

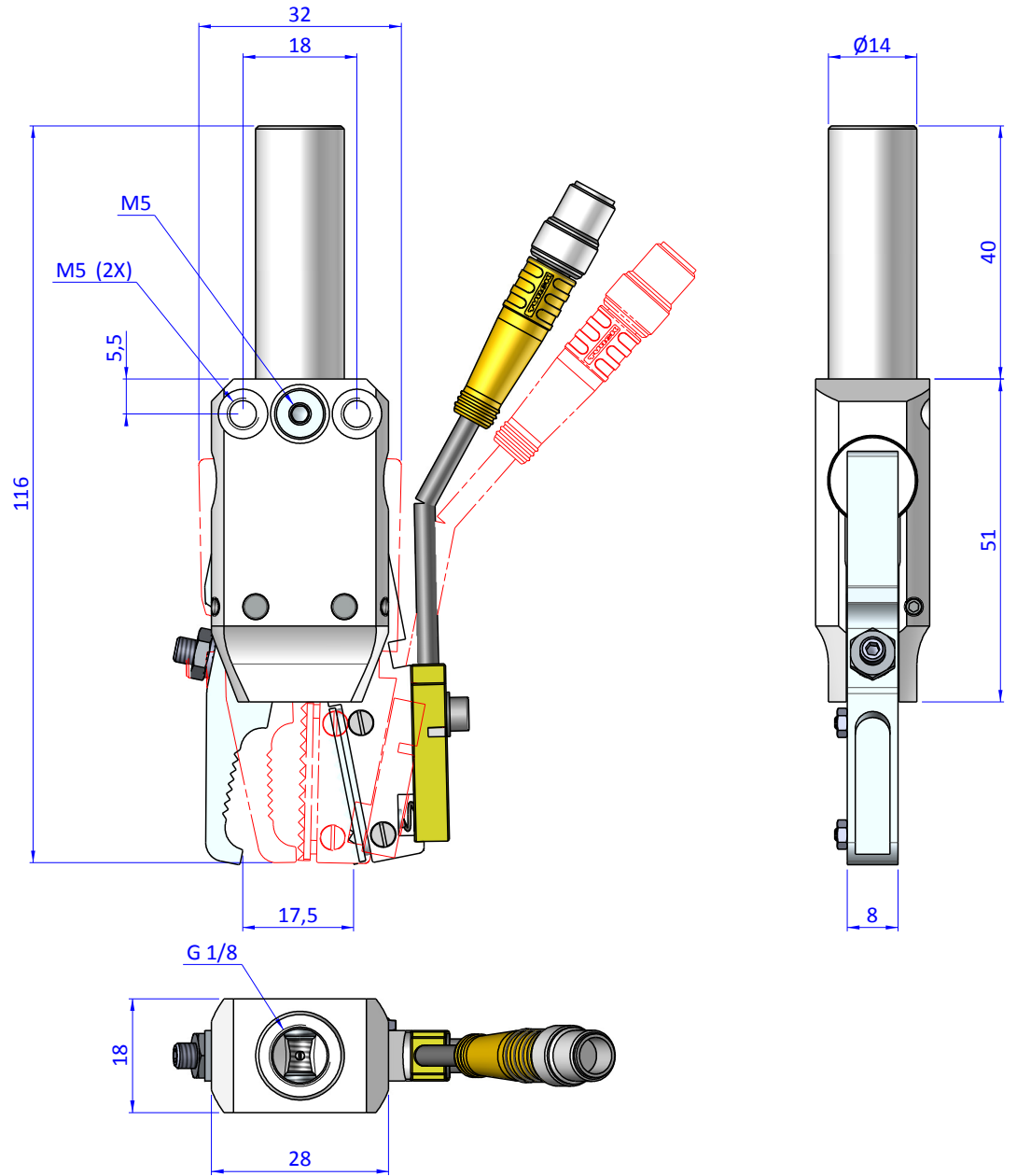

THE PROPERTY OF THE DRAWING IS ESTABLISHED BY LAW. IT IS FORBIDDEN TO PRODUCE OR SHOW IT TO THIRD PARTY, WITHOUT A WRITTEN AGREEMENT.

Item	Name	Q. ty
1	GTS.03.14	1
2	GTS.03.15	1
3	GTS.03.G18	1

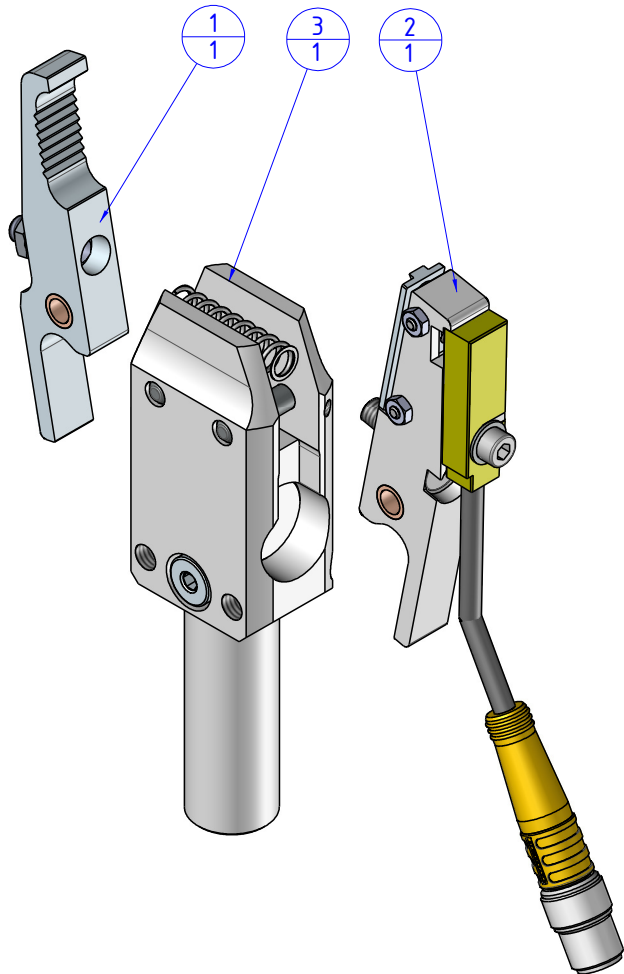

Format A3

UNI 936-76

 FPS FPSERVICES AUTOMATION		DESIGNED FROM		REVIEW
		FPS Automation		A
GENERAL TOLERANCE		DATE	WEIGHT	
UNI - ISO 2768		22/03/2019	0,092kg	
CLASSE f		CODE		
		CA.GTS.1003.1415		CA.GTS.1003.1415